



**Introduction of energy savings  
by CO2 refrigeration systems  
in SM/CVS**

Feb. 3<sup>rd</sup> 2014  
Panasonic Corporation  
Air-Conditioner Division  
Gaku Shimada

- 1. CO2 Compressor and Application Roadmap**
2. Introduction of CO2 system for CVS and SM
3. Actual Installation and Monitored Energy Saving Data
4. Issues and Future action

# 1. CO<sub>2</sub> Compressor and Application Road Map

From 300W to 7,500W(10HP) Compressor and Heating / Cooling applications

Heating

Domestic Heat Pump  
Water Heater



Heat Pump for Space Heating



Commercial Water Heater

33F

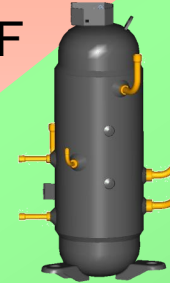

Heating and Cooling  
Combined Products

20F

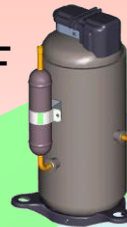

15F

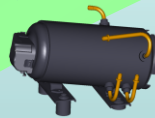
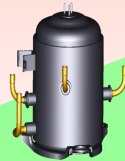

CO<sub>2</sub> Compressor  
Technologies

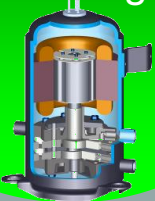

Commercial Refrigerators  
and Freezers



Light Commercial Bottle Coolers



Refrigeration

# AGENDA

1. CO2 Compressor and Application Roadmap
2. Introduction of CO2 system for CVS and SM
3. Actual Installation and Monitored Energy Saving Data
4. Issues and Future action

# 2-1. CO<sub>2</sub> System for Convenience Store (CVS)

## ◆ Layout image

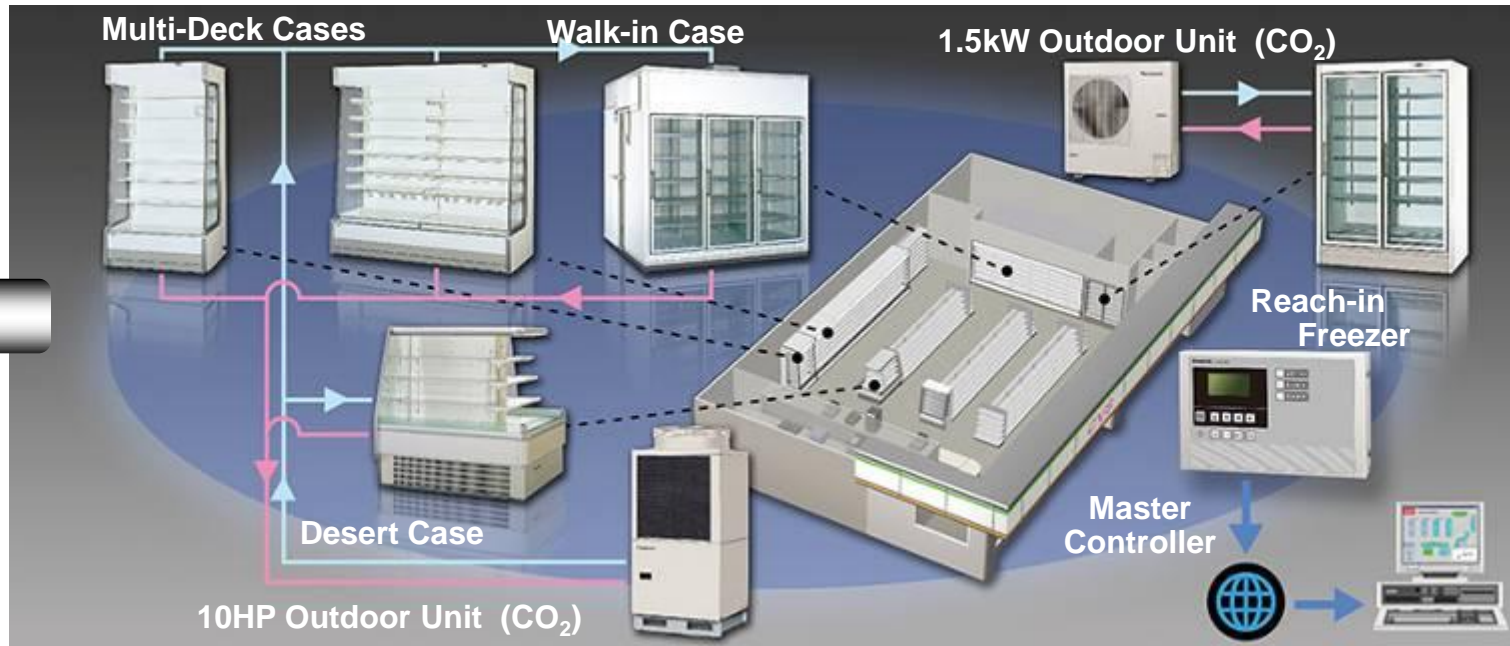

## ◆ Key Technologies

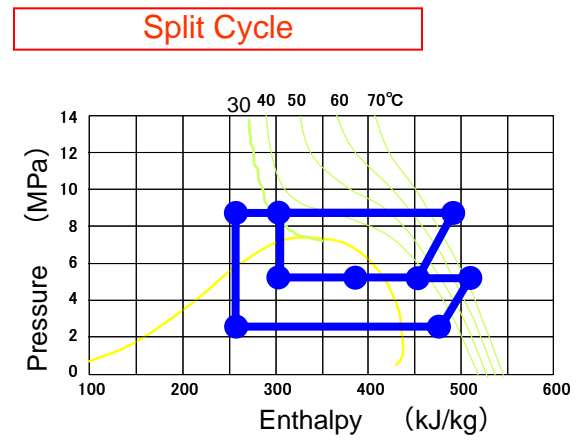
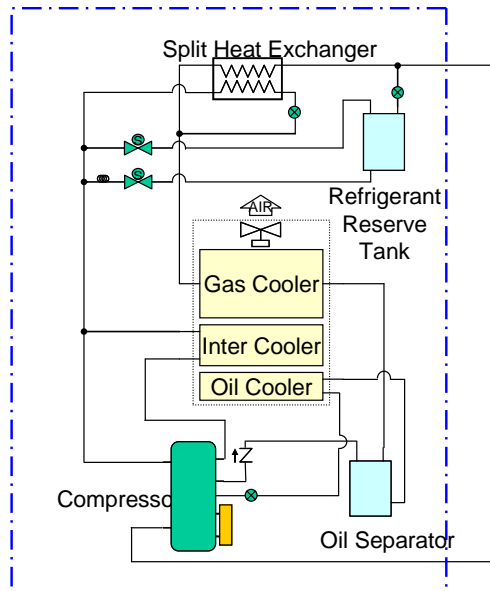
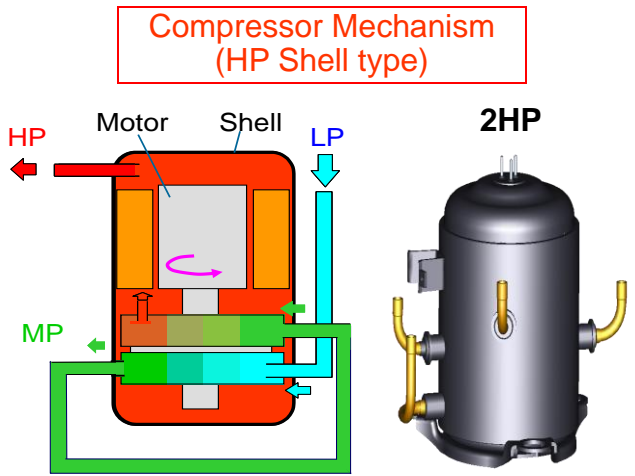

# 2-2. CO2 System for Supermarket (SM)

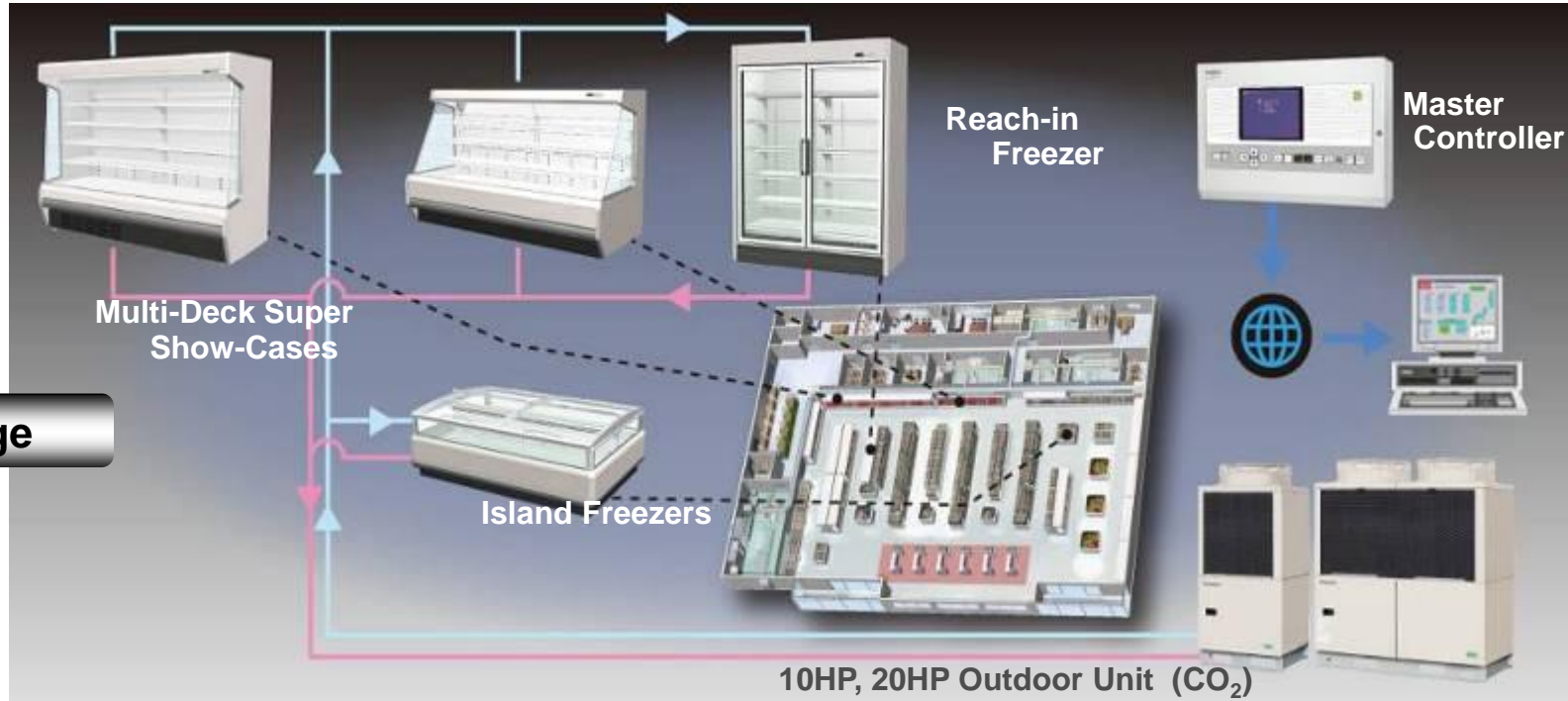

◆ Layout image

◆ Key Technologies

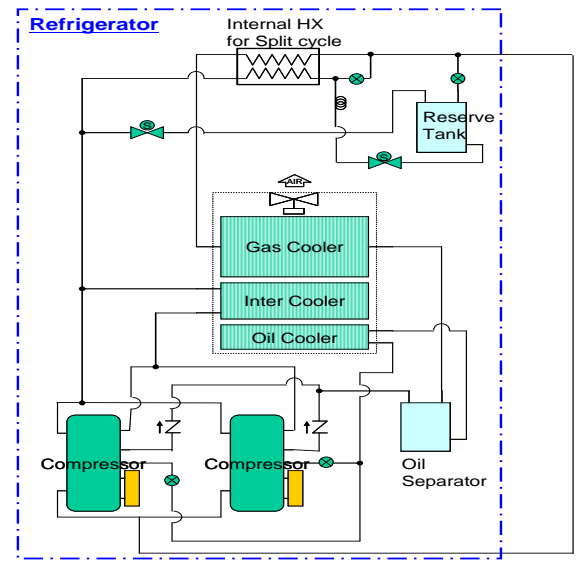
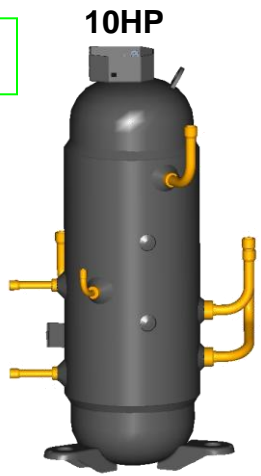
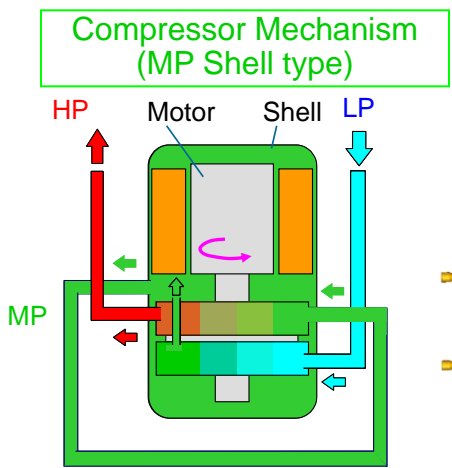

Split Cycle

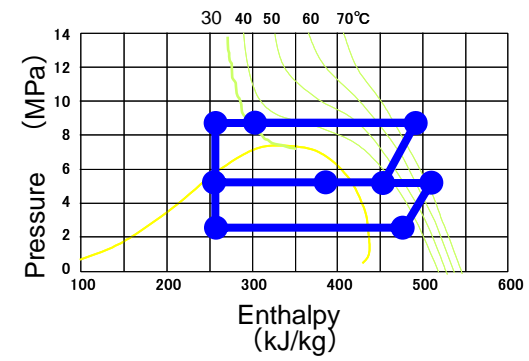

# AGENDA

1. CO2 Compressor and Application Roadmap
2. Introduction of CO2 system for CVS and SM
3. Actual Installation and Monitored Energy Saving Data
4. Issues and Future action

# 3-1. Actual Installation in Japan (Dec. 2013)

■ After the collaborative verification of system performance with key accounts and government, mass production started in 2010.

■ As of today, **4 5 0** CO2 units were installed in **1 4 5** locations,

From subarctic **Hokkaido** (北海道) to subtropics **Okinawa** (沖縄),

From **CVS** to **Hypermarket** including **Distribution Center**.

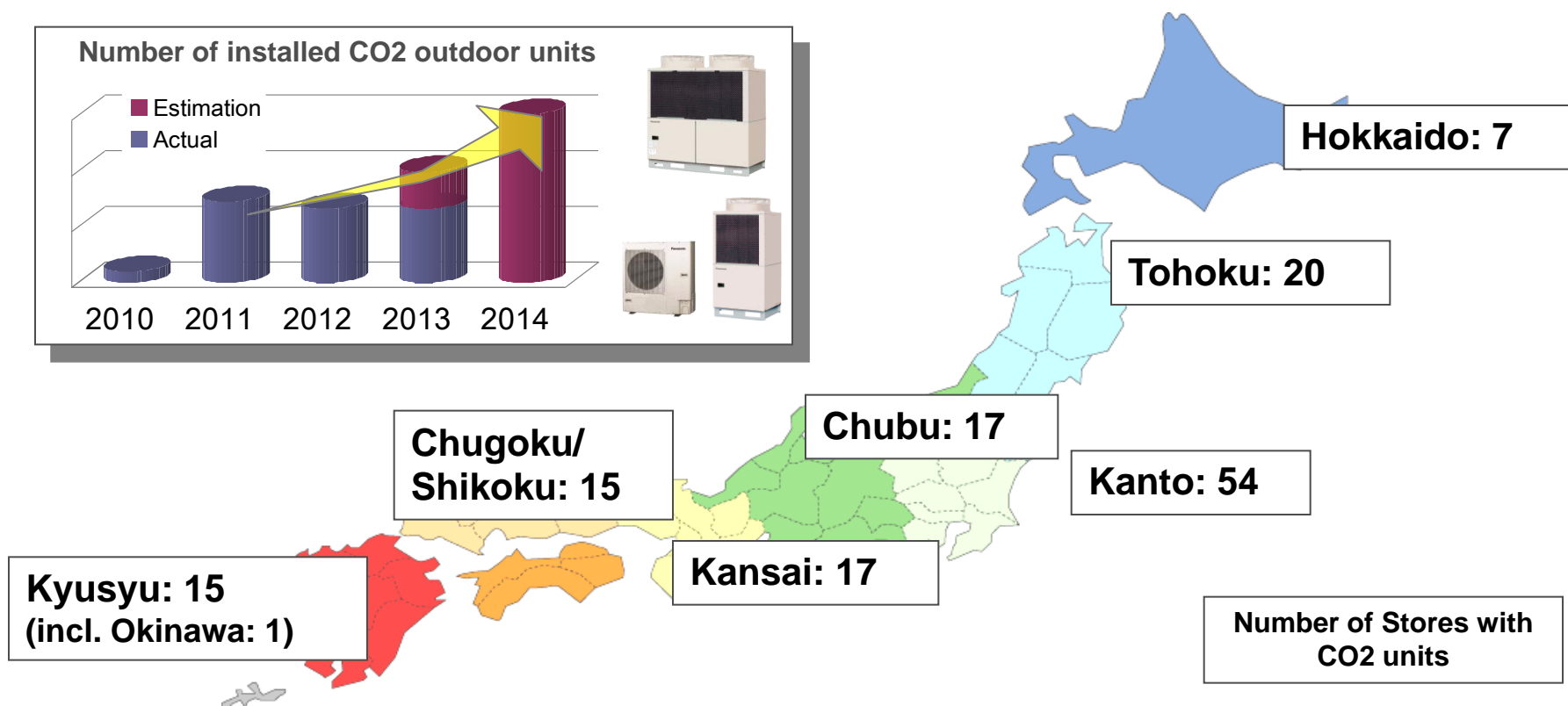
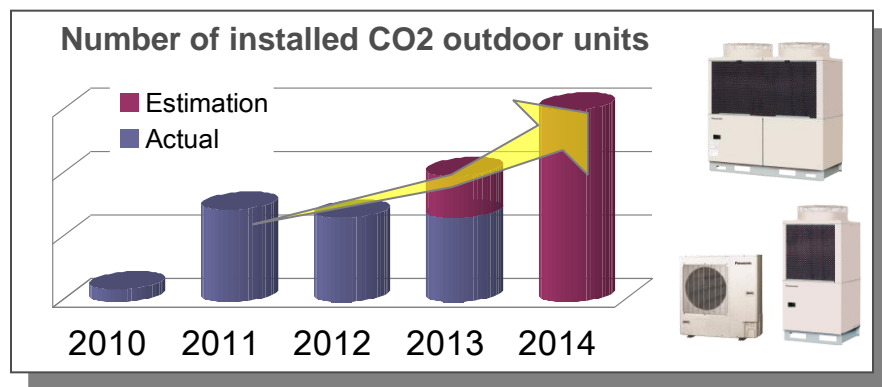



# 3-2. Monitored Energy Consumption Data (CVS and SM)

**CVS**

Annual Energy Saving

**26%**

Miyagi  
Annual Ave. Temp.: 12.2 (C)

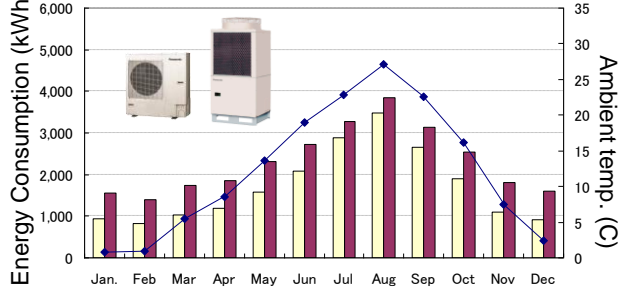

Annual Energy Saving

**21%**

Chiba  
Annual Ave. Temp.: 20.9 (C) (May-Dec)

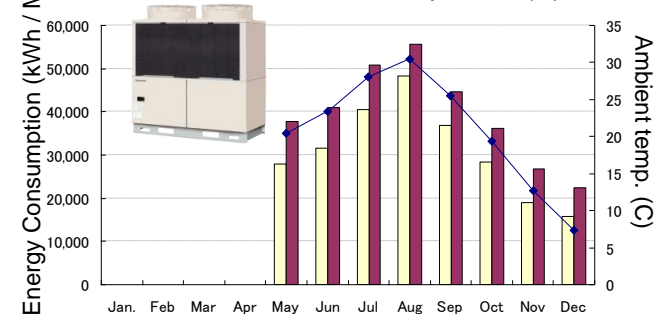

**SM**

Annual Energy Saving

**19%**

Aichi  
Annual Ave. Temp.: 16.0 (C)

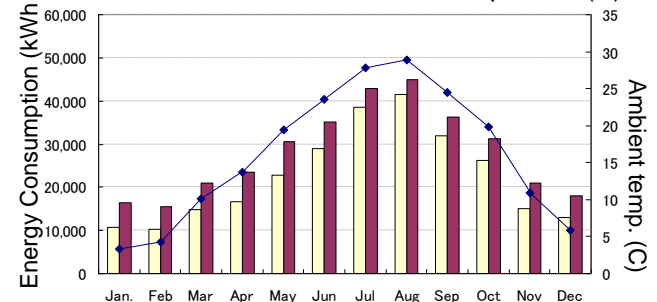

Annual Energy Saving

**10%**

**CVS**

Okinawa  
Annual Ave. Temp.: 23.6 (C)

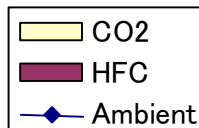
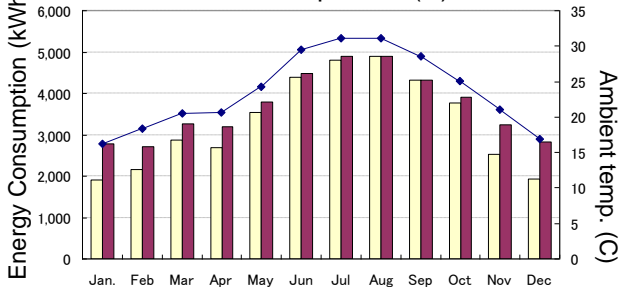

CO2 unit energy consumption is fairly compared with simulated data of Panasonic HFC unit.

# AGENDA

1. CO2 Compressor and Application Roadmap
2. Introduction of CO2 system for CVS and SM
3. Actual Installation and Monitored Energy Saving Data
4. Issues and Future action

# 4-1. Issues of CO2 units and our Future Action

## 1. Acquisition Cost Reduction

→ System Design simplification, Piping materials (tube and fittings) standardization and availability / access improvement.

The reduction of cycles per store will also reduce the total cost.  
(High Pressure Gas Safety Law need to be amended for CO2.)

## 2. Product Improvement

→ Efficiency, Noise, and Vibration can be further improved.

Product Line-up need to be improved.

Indoor units to be diversified and Outdoor units to be standardized.

## 3. Training of Installers

→ Trainings for CO2 are indispensable. (Installation, Operation check, and Service Maintenance)

Original Manual was prepared and Training courses were held.

	FY2010	FY2011	FY2012	FY2013
# of Trainee	46	200	211	(250)

More than 650 people already took CO2 training course as of Dec. 2013

## 4-2. Issues of CO2 units and our Future Action

In order to expand the use of CO2 refrigerant for Commercial Refrigeration Sector in Japan, Cooperative actions in different levels of industry Stake holders are required.

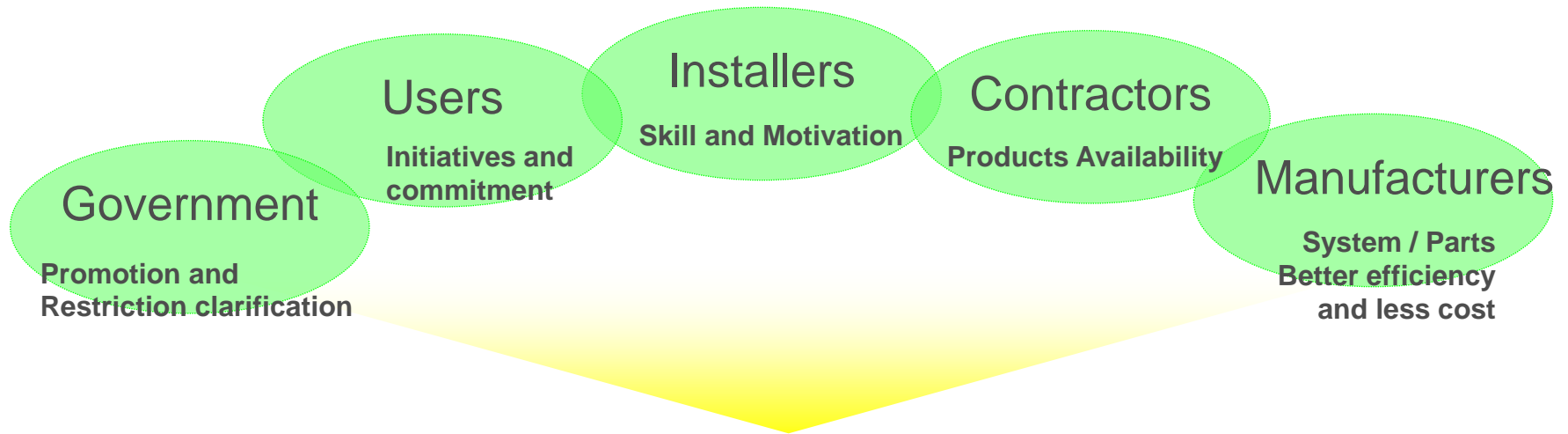

**Contribute to the prevention of  
Global Warming by utilizing CO2**



**ATMO**  
**sphere**  
technology & innovation  
**natural refrigerants**  
3-5 February 2014, Tokyo

---

Thank you very much!